

TRAVERSE DI SOLLEVAMENTO

JACKING BEAMS
TRAVERSES DE LEVAGE
SCHERENHEBER

Made in Italy 

**TOP
LINE**

✓ **SERIE 400**
 ✓ **SERIE 800**



ART. 459

ART. 459 • 459/A

TRACCIATO TECNICO COSTRUTTIVO

- Traversa di sollevamento per auto e veicoli commerciali.
- Altezza chiusa molto ridotta per sollevare agevolmente vetture dalla carrozzeria ribassata.
- Staffa meccanica di stazionamento a garanzia di massima sicurezza.
- Valvola di massima pressione per impedire carichi superiori alla portata nominale.
- **Set di supporti in gomma e coppia di distanziali forniti di serie.**
- Rulli di guida in acciaio dotati di cuscinetti a sfera.
- Comando di discesa "uomo presente".
- **Art. 459:** Traversa con pompa idropneumatica.
- **Art. 459/A:** Traversa con pompa a mano.

TECHNICAL AND STRUCTURAL LAY-OUT

- Lifting crosspiece for cars and vans.
- Low profile when closed to lift low profile vehicles.
- Mechanical parking bracket to guarantee the maximum safety.
- Maximum pressure valve to avoid loads exceeding the nominal capacity.
- **Delivered with a set of rubber supports and a pair of spacers.**
- Steel-made driving rolls with ball-bearings.
- "Man-standing-by" lowering control.
- **Art. 459:** Crosspiece with a hydro-pneumatic pump.
- **Art. 459/A:** Crosspiece with a hand-pump.

ACCESSORI EXTRA DOTAZIONE

EXTRA EQUIPMENT • ACCESSOIRES EN OPTION • EXTRA ZUBEHÖR

**ART. A459
ADATTATORI**

Adaptors
 Adaptateurs
 Adapter

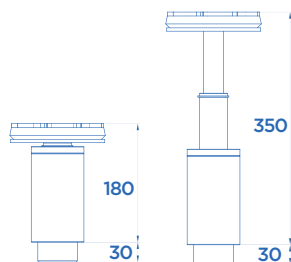

KIT X2

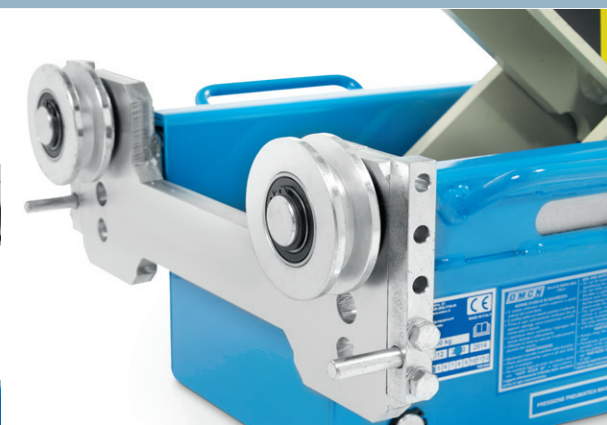

RELEVÉ TECHNIQUE

- Traverse de levage pour voitures et utilitaires.
- Hauteur réduite en position fermée pour la prise sous coque des voitures surbaissées.
- Crémaillère de stationnement pour une sécurité optimale.
- Soupape de pression maximale pour éviter tout danger de surcharge (charge supérieure à la capacité déclarée).
- **Kit de rallonges et supports en caoutchouc fourni.**
- Rouleaux de guide en acier sur roulements à billes.
- Commande de descente "homme mort".
- **Art. 459:** Traverse avec pompe hydropneumatique.
- **Art. 459/A:** Traverse avec pompe manuelle.

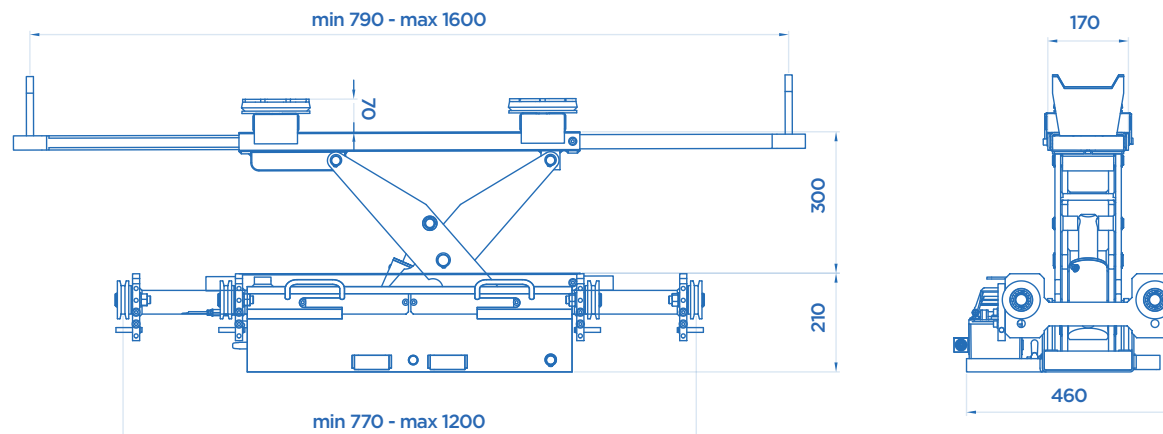

TECHNISCHE UND KONSTRUKTIVE ANGABEN

- Achsfreiheber für das Heben von Autos und Nutzfahrzeuge.
- Ermäßigte Höhe, wenn geschlossen, um Fahrzeuge mit tiefergelegter Karosserie einfach anzuheben.
- Mechanische Zahnstange, um die maximale Sicherheit zu sichern.
- Max. Drückventil, um das Heben von Ladung über die Nominallastkapazität zu verbieten.
- **Mit einem Kit von Gummiauflagen und einem Paar von Distanzstücke.**
- Aus Stahl gemachte Führungsrollen mit Kugellagern.
- „Totmann-Absenksteuerung“.
- **Art. 459:** Achsfreiheber mit einer hydropneumatische Pumpe.
- **Art. 459/A:** Achsfreiheber mit einer Handpumpe.

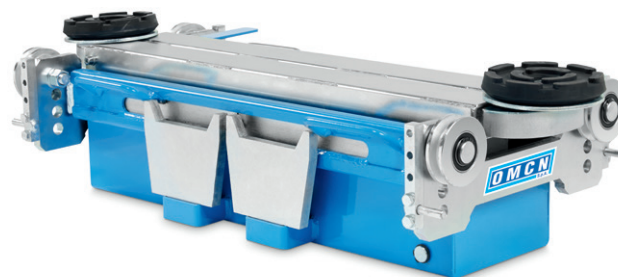

ART. 459/A



ART.		
459	2500 kg	8 bar
459/A	2500 kg	

 Alimentazione pneumatica • Pneumatic feeding
 • Pression d'alimentation • Benötigter Luftdruck

ART. 203



 **SERIE 400**

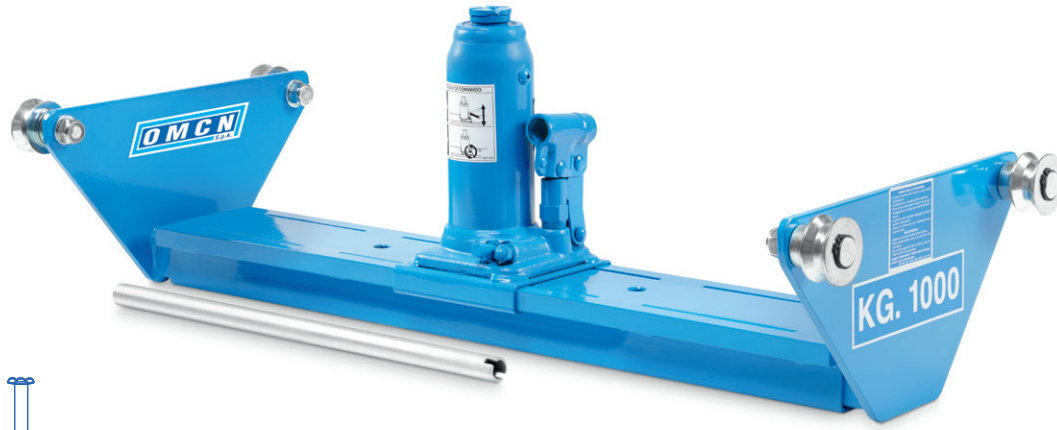
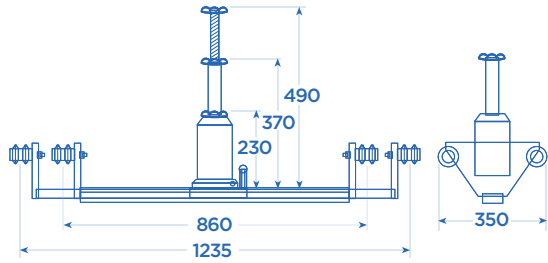

ART. 
203 | 1000 kg

ART. 450



 **SERIE 400**

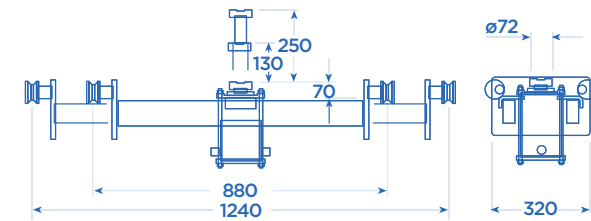

ART.  
450 | 1000 kg | 10 bar

 Alimentazione pneumatica • Pneumatic feeding • Pression d'alimentation • Benötigter Luftdruck

ART. 450/A



✓ **SERIE 400**

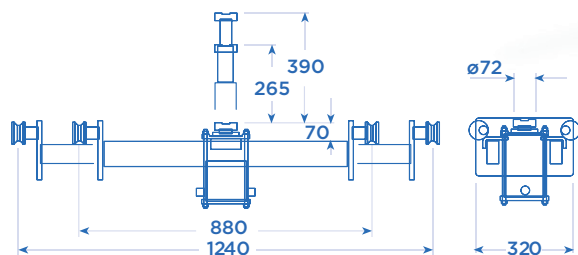

Alimentazione pneumatica • Pneumatic feeding • Pression d'alimentation • Benötigter Luftdruck



ART.  
450/A | 1000 kg | 10 bar

ART. 460



ART.



460 | 2500 kg | 8 bar

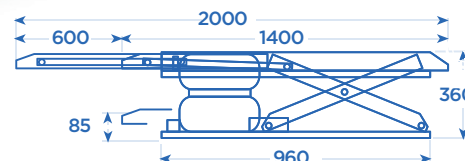

Alimentazione pneumatica • Pneumatic feeding • Pression d'alimentation • Benötigter Luftdruck

ART. 460

TRACCIATO TECNICO COSTRUTTIVO

- Sollevatore interamente pneumatico.
- Struttura portante a forbice robusta e compatta, con prolunga estensibile porta tamponi.
- Sollevatore a basso profilo per la massima facilità di accesso.
- Valvola di sicurezza contro i sovraccarichi.
- Velocità di discesa controllata.
- Dotato di dispositivo meccanico di sicurezza.

TECHNICAL AND STRUCTURAL LAY-OUT

- Completely pneumatic lift.
- Sturdy and compact scissor carrying structure, with holder-pads extension.
- Low profile lift for a very easy going up.
- Overload safety valve.
- Checked descent speed.
- Equipped with a safety mechanical device.

RELEVÉ TECHNIQUE

- Elévateur complètement pneumatique.
- Structure portante à ciseaux robuste et compacte, avec rallonge extensible porte-tampons.
- Elévateur surbaissé pour faciliter la montée des véhicules.
- Soupape de sûreté contre les surcharges.
- Vitesse de descente contrôlée.
- Equipé avec un dispositif mécanique de sûreté.

TECHNISCHE UND KONSTRUKTIVE ANGABEN

- Scherenheber mit pneumatischem Antrieb.
- Stabiles Scherentraggestell mit verstellbaren Tragarmverlängerungen.
- Scherenheber mit niedrigem Gestellprofil zur Einsatzerleichterung.
- Überdruckventil für den Überlastungsschutz.
- Sicherheitsventil für die Überwachung der Absenkgeschwindigkeit.
- Mechanische Sicherheitsvorrichtung gemäß der Europäischen Norm.

HEAVY DUTY

✓ **ART. 405 • 406 • 407**
 ✓ **SERIE 900**

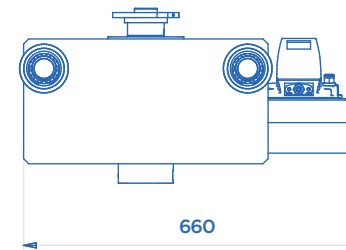
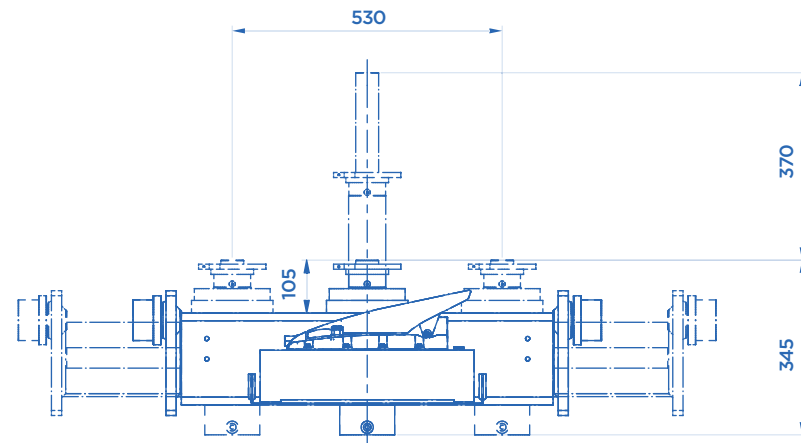

ART.  
458/B | 5000 kg | 8 bar

ART. 458/B

 Alimentazione pneumatica • Pneumatic feeding • Pression d'alimentation • Benötigter Luftdruck

TRACCIATO TECNICO COSTRUTTIVO

- Dotata di un singolo cilindro traslabile lateralmente.
- Azionamento tramite pompa idropneumatica
- **Grande corsa di sollevamento (370 mm).**
- Valvola di massima pressione per impedire carichi superiori alla portata nominale.
- Rulli di guida in acciaio dotati di cuscinetti a sfera.
- Comando di discesa "uomo presente".

TECHNICAL AND STRUCTURAL LAY-OUT

- One laterally movable cylinder.
- Hydro-pneumatic pump.
- **Long lifting stroke (370 mm).**
- Maximum pressure valve to avoid loads exceeding the nominal capacity.
- Steel-made driving rolls with ball-bearings.
- "Man-standing-by" lowering controls.

RELEVÉ TECHNIQUE

- Vérin unique mobile (déplacement latéral).
- Fonctionnement à pompe hydropneumatique.
- **Longue course de levage (370 mm).**
- Soupape de sécurité pour éviter tout danger de surcharge (charge supérieure à la capacité déclarée).
- Rouleaux de guide en acier sur roulements à billes.
- Commande de descente "homme mort".

TECHNISCHE UND KONSTRUKTIVE ANGABEN

- Mit einem seitenbewegbaren Zylinder.
- Steuerung ausführbar dank einer hydropneumatischen Pumpe.
- **Lang Kolbenhub (370 mm).**
- Max. Drückventil um das Heben von Laduns über die Nominallastkapazität zu verbieten.
- Aus Stahl gemachte Führungsrollen mit Kugellagern.
- „Totmann-Absenksteuerung“.

**HEAVY
DUTY**

ART. 458/A ✓ **SERIE 900**
ART. 458/C ✓ **ART. 406 • 407**

ART.		
458/A	13500 kg	8 bar
458/C	10000 kg	8 bar

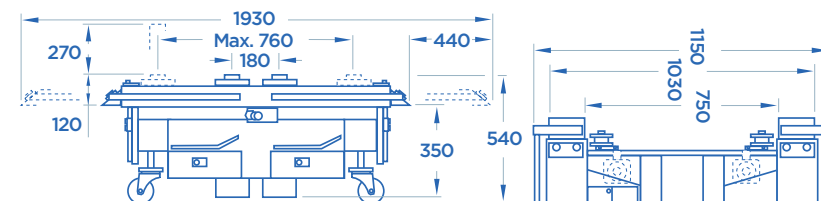

ART. 458/A

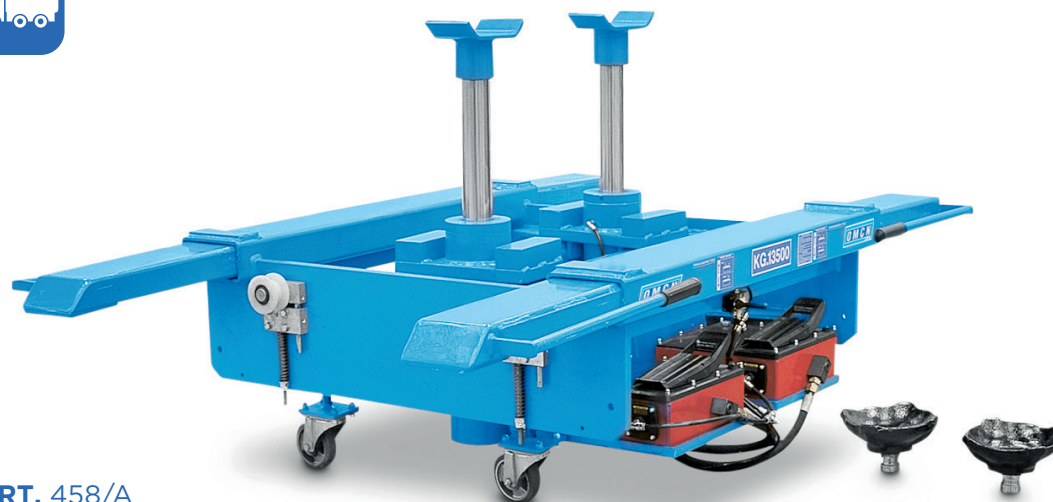

ART. 458/A

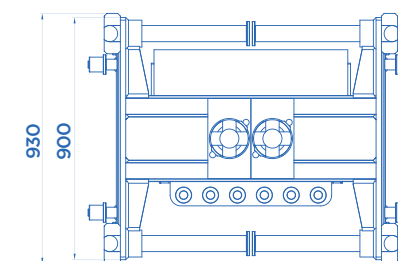
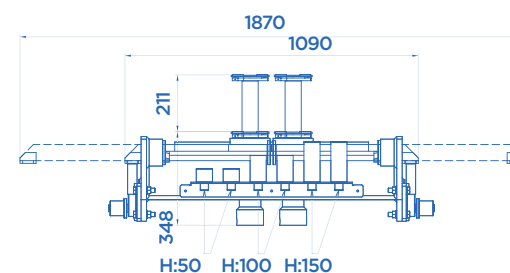

ART. 458/C

 Alimentazione pneumatica • Pneumatic feeding • Pression d'alimentation • Benötigter Luftdruck

TRACCIATO TECNICO COSTRUTTIVO

- Dotate di due cilindri traslabili lateralmente.
- Azionamento tramite due pompe idropneumatiche.
- Possibilità di controllare i due cilindri in modo indipendente uno dall'altro.
- Grande corsa di sollevamento.
- **Set di supporti a U forniti di serie** (Art. 458/A).
- **Dotata di 4 ruote pivotanti per una facile movimentazione senza accessori aggiuntivi** (Art. 458/A).
- **Set di prolunghe di varie altezze fornite di serie** (Art. 458/C).
- Valvola di massima pressione per impedire carichi superiori alla portata nominale.
- Comando di discesa "uomo presente"

TECHNICAL AND STRUCTURAL LAY-OUT

- Two laterally movable cylinders.
- Two hydro-pneumatic pumps.
- Both cylinders can move separately.
- Long lifting stroke.
- **Delivered with a set of U-supports** (Art. 458/A).
- **Equipped with four pivot wheels for an easy move without any additional accessories** (Art. 458/A).
- **Delivered with a set of extensions of different heights** (Art. 458/C).
- Maximum pressure valve to avoid loads exceeding the nominal capacity.
- Man-standing-by lowering control.

RELEVÉ TECHNIQUE

- Deux vérins mobiles (déplacement latéral).
- Fonctionnement via deux pompes hydro-pneumatiques.
- Vérins indépendants l'un de l'autre.
- Longue course de levage.
- **Paire de supports à fourche fournie** (Art. 458/A).
- **4 roues pivotantes de série pour faciliter les déplacements** (Art. 458/A).
- **Kit de rallonges de différentes hauteurs fourni** (Art. 458/C).
- Soupape de sécurité pour éviter tout danger de surcharge (charge supérieure à la capacité déclarée).
- Commande de descente "homme mort".

TECHNISCHE UND KONSTRUKTIVE ANGABEN

- Mit zwei seitenbewegbaren Zylindern.
- Steuerung ausführbar dank zwei hydropneumatischen Pumpen.
- Unabhängig-kontrollierbare Zylinder.
- Lang Kolbenhub.
- **Mit einem Kit von U-Auflagen** (Art. 458/A).
- **Mit vier lenkbaren Rädern für eine einfache Bewegung ohne weiteres Zubehör** (Art. 458/A).
- **Mit einem Kit von Verlängerungen mit verschiedenen Höhen** (Art. 458/C).
- Max. Drückventil um das Heben von Laduns über die Nominallastkapazität zu verbieten.
- „Totmann-Absenksteuerung“.